

2005-09-30

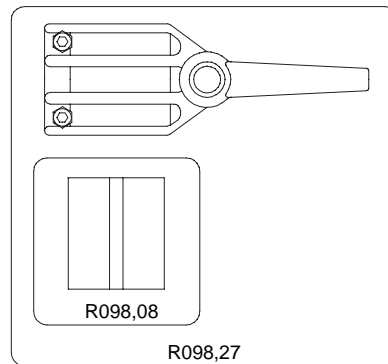

R098,27

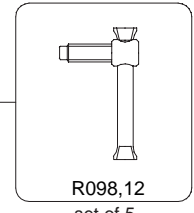
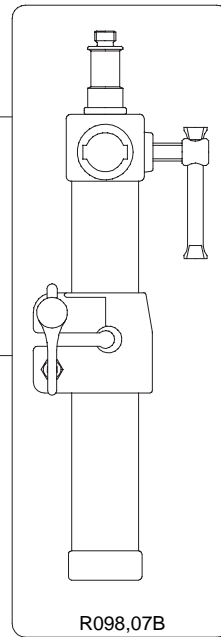
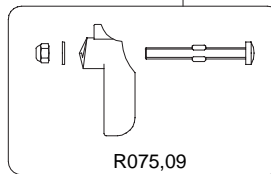
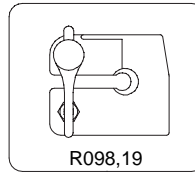
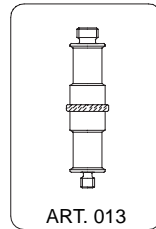
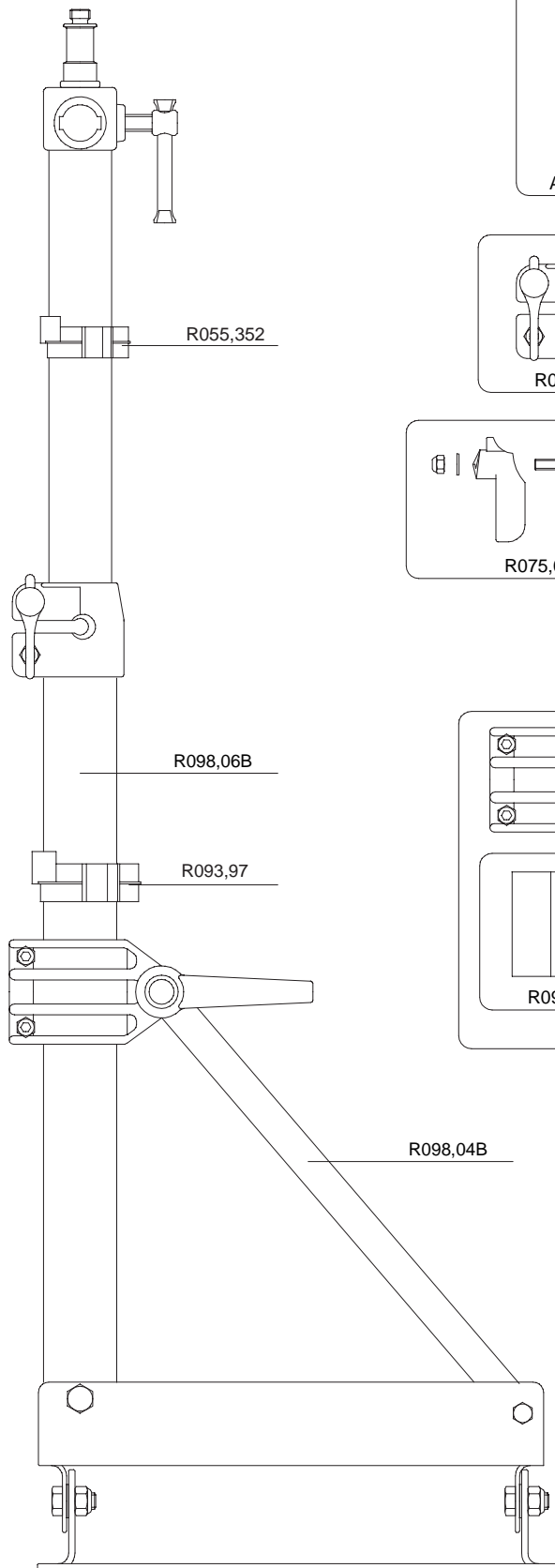